



Access & Power Integration

Trove1AL1R

- Trove rack enclosure with
Altronix backplane (TAL1R)

Installation Guide

All registered trademarks are property of their respective owners.



Rev. TALR102518

More than just power.™

Installing Company: _____ Service Rep. Name: _____

Address: _____ Phone #: _____

Overview:

Altronix Trove1AL1R accommodates various combinations of Altronix power supply/charger boards and sub-assemblies.

Specifications:

Agency Listings:

- CE European Conformity.

Trove1AL1R

Trove1R rack mount enclosure with TAL1R Altronix backplane.

- 16 Gauge black enclosure with ample knockouts for convenient access.
- Modular 2U standard EIA 19" drawer with extendable slides up to 48".
- Dimensions (H x W x D): 3.375" x 19.0" x 26.5" (85.8mm x 482.6mm x 673.1mm).
- Includes tamper switch (Altronix Model TS112 or equivalent) and cam lock.

TAL1R

Altronix backplane.

- 16 Gauge backplane.
- Dimensions (H x W x D): 18.5" x 15.25" x 0.3125" (469.9mm x 387.4mm x 7.9mm).

Optional Accessories:

- RE2: Rack Mount Battery Enclosure accommodates up to four (4) 12VDC/7AH batteries
- WM5, WM25, WM100: Magnetic Cable Tie Mounts (5, 25, 100 counts).
- LC3: 6 ft. three-wire line cord.

Backplane Accommodates a Combination of the Following:

- Up to two (2) eFlow4NB, eFlow6NB, eFlow102NB, or eFlow104NB.
- Up to four (4) ACM8(CB) or ACMS8(CB).
- Up to two (2) ACM4(CB), MOM5, PD4UL(CB), PD8UL(CB), PDS8(CB), or VR6.

Hardware and Accessories:



Spacer |



5/16" Pan Head Screw |



Lock Nut

Installing Trove1R into Rack Tower:

Wiring methods shall be in accordance with the National Electrical Code/NFPA 70/ANSI, and with all local codes and authorities having jurisdiction. These products are for indoor use only and must be installed within the protected premises.

Note: First assemble and Install Z Bracket Wire Management Accessory (refer to Z Bracket Installation pg. 4)

1. Remove backplane from enclosure prior to installing into rack cabinet (do not discard hardware).
2. In order to mount included UL Listed tamper switch (Altronix Model TS112 or equivalent) turn the enclosure upside down. Punch out the knockout in designated location, on the back of the unit, from outside of the drawer (Fig. 1, pg. 3). Insert the tamper switch into the knockout from outside of the drawer with the button facing outwards and spaded connectors inside the drawer. Connect tamper switch wiring to the Access Control Panel input or the appropriate UL Listed reporting device.
To activate alarm signal open the rack drawer.

Fig. 1
Back of the drawer,
viewed from outside.

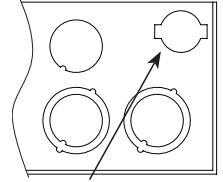

Tamper Switch
mounting location

3. Slide the rack enclosure into an open 2U location in the four post rack cabinet.
4. Utilizing proper fasteners attach front ears to the rack rails.
5. Attach the rear of the adjustable slides to the rear rails of the rack cabinet with the proper fasteners.
6. Secure the rack cover (Fig. 2a, pg. 3) and rack drawer to earth ground (Fig. 2b, pg. 3).

Fig. 2

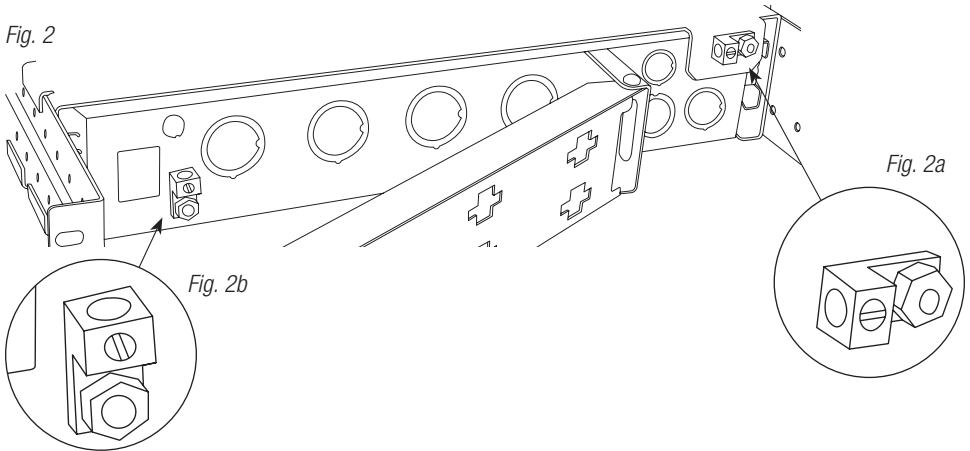

Fig. 2a

Fig. 2b

7. Ensure that all internal configurations (voltage selection, switch settings, etc.) are completed before mounting backplane back into Trove rack enclosure.

Assembling and Attaching

Z Bracket Wire Management Accessory (included):

Altronix Trove Rack enclosures include Z Bracket, a convenient and reliable wire management accessory.

Hardware (included):

 Ten (10) bolts and  eight (8) lock nuts.

1. Carefully unpack Z Bracket. Do not discard hardware (included) (Fig. 3, pg. 4).
2. Attach arms to each other using bolts and lock nuts (Fig. 3a, pg. 4).
3. Attach the hinge brackets to the ends of arms using bolts and nuts positioning them as shown on (Fig. 3b, pg. 4).
4. Make sure that all nuts are tightened.

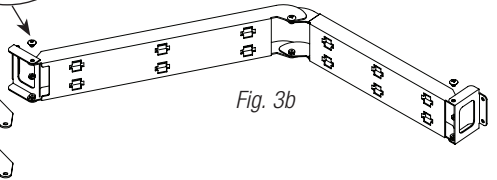
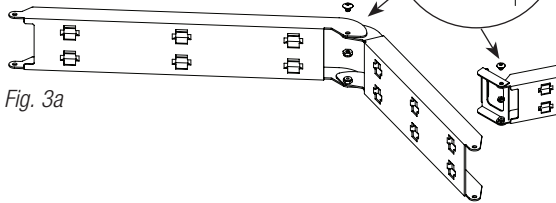
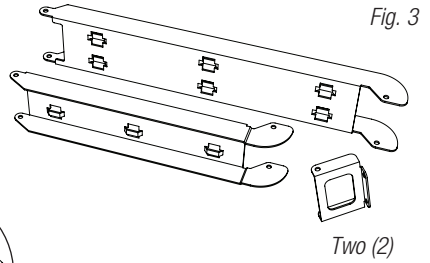

5. Attach the hinge bracket on the longer side of Z Bracket to the adjustable slide using bolts and lock nuts (included) (Fig. 4, 4a, pg. 4).
6. Attach the hinge bracket on the shorter side of Z Bracket to the rear of the rack enclosure using bolts (included).

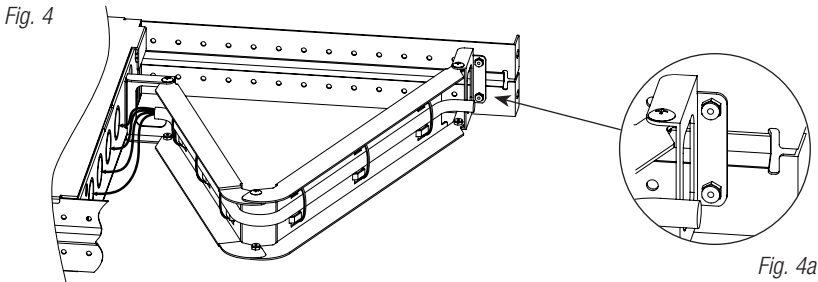

TAL1R:

Configuration of Altronix Power Supply and/or Sub-Assembly Boards

1. Fasten spacers onto metal pems configuration (A), (B) or (C) of backplane depending on the board (Fig. 5, pg. 5).
2. Position power supply or sub-assembly over corresponding spacers and fasten screws into spacers (Fig. 5a, pg. 5).
3. Mount backplane to enclosure with hardware.

Position Chart for the Following Models:

Altronix Power Supply/Charger or Sub-Assembly	Pem Mounting
eFlow4NB, eFlow6NB, eFlow102NB, or eFlow104NB	(A)
ACM8(CB), ACMS8(CB)	(B)
ACM4(CB), MOM5, PD4UL(CB), PD8UL(CB), PDS8(CB), PD16W(CB) or VR6	(C)

Fig. 5

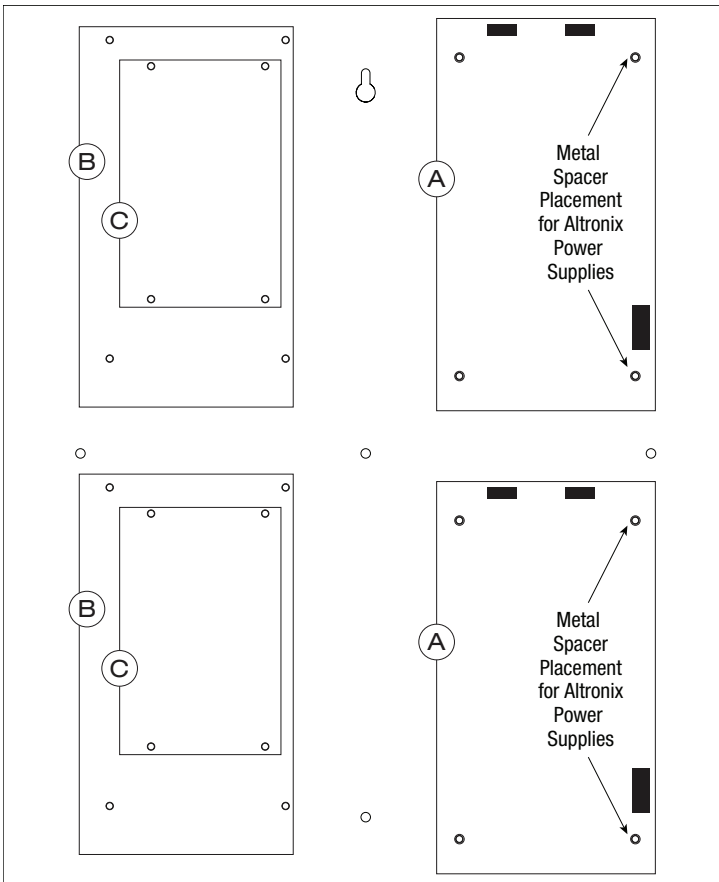
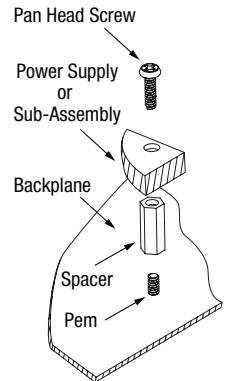

Fig. 5a



Notes:

TAL1R Backplane Dimensions (H x W x D):

18.5" x 15.25" x 0.3125" (469.9mm x 387.4mm x 7.9mm)

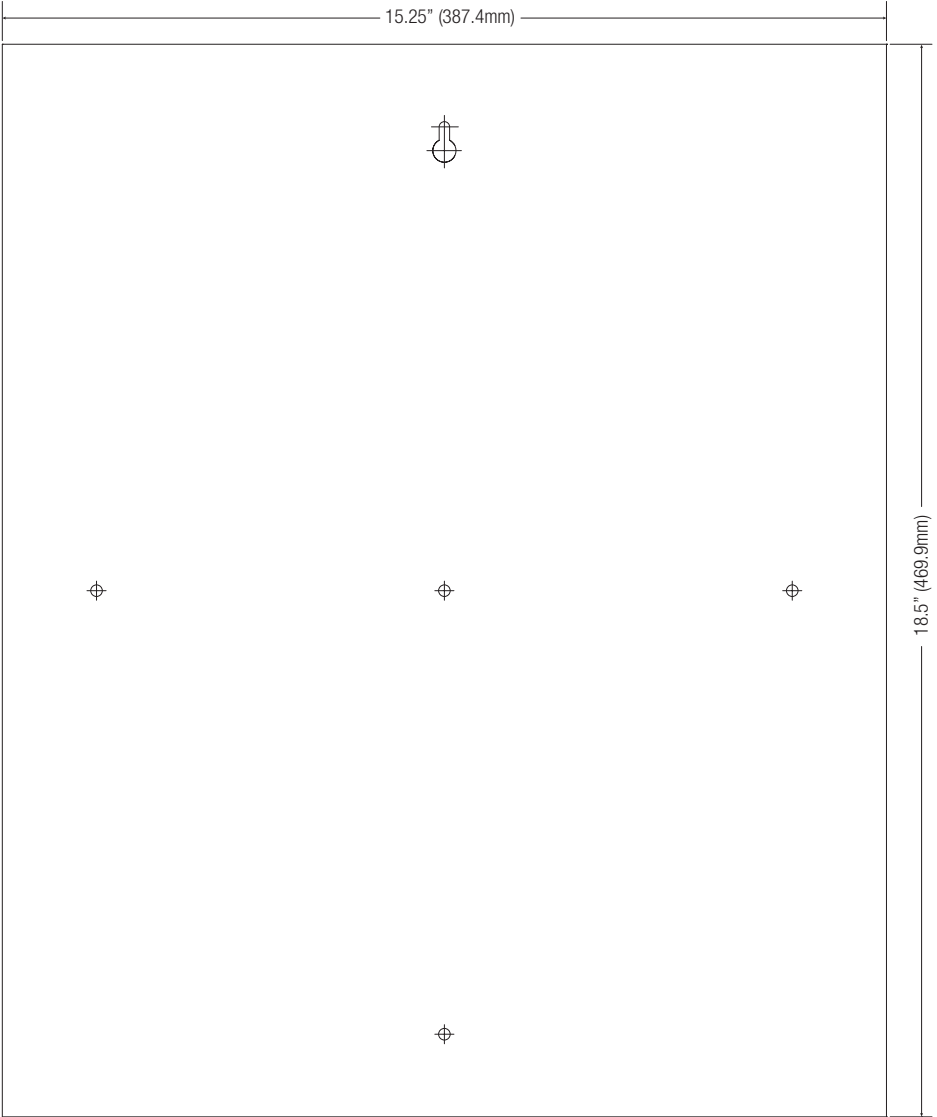

Trove1R Enclosure Dimensions:

3.375" x 19.0" x 26.5" (85.8mm x 482.6mm x 673.1mm). Shown with Z Bracket attached.

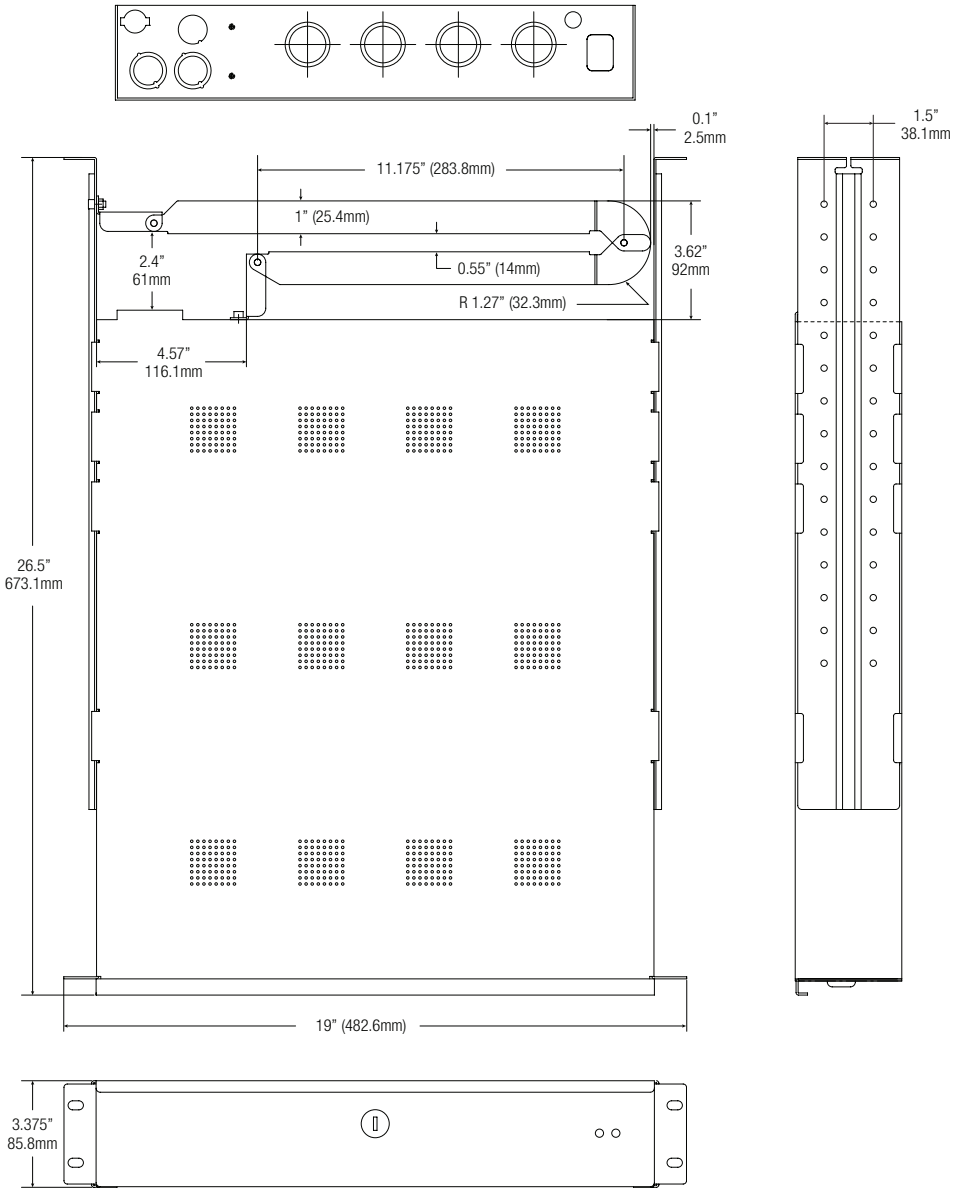

Altronix is not responsible for any typographical errors.

140 58th Street, Brooklyn, New York 11220 USA | phone: 718-567-8181 | fax: 718-567-9056
 website: www.altronix.com | e-mail: info@altronix.com | Lifetime Warranty
 IITrove1AL1R 101U

